



ZENO

Pagina 128

Design:
Danilo Bonfanti

STRUTTURA

Struttura in legno e multistrato imbottita in poliuretano a quote differenziate e rivestita in resinato accoppiato dello spessore di 10 mm.

MOLLEGGIO

Molleggio della seduta in nastri elastici intrecciati ad alta densità.

SEDUTA

Cuscini di seduta in poliuretano densità minima 30 HR rivestiti da una falda Dacron.

SCHIENALE

Schienale Standard: cuscini 50% in piuma naturale depolverizzata, lavata e sterilizzata - 50% poliuretano, a camere separate orizzontalmente interamente rivestiti da una tela in cotone 100%.

Schienale su richiesta: cuscini 50% in memory foam - 50% poliuretano a camere separate orizzontalmente interamente rivestiti da una tela in cotone 100%.

STRUCTURE

Laminated wood structure padded with polyurethane foam of different densities and covered in a 10 mm layer of bonded resin.

SUSPENSION

The seat suspension system uses high-density intertwined elastic bands.

SEAT

Polyurethane padding seat cushions with a minimum density of 30 HR covered in a layer of Dacron.

BACKREST

Standard backrest: cushions 50% natural dust-free, washed and sterilized Down padding - 50% Polyurethane arranged in separate horizontal chambers, 100% cotton fabric cover.

Backrest on request: backrest cushions 50% memory foam - 50% polyurethane arranged in separate horizontal chambers, 100% cotton fabric cover.

PIEDINI / FOOT



LAMINA / LAMINA FOOT

Satinato / Satin
Brunito / Burnished
h. 7,5 cm
A richiesta / On request
h.9,5 cm



QUADRATO / SQUARE FOOT

A sezione quadrata / Square section
h.7,5 cm
A richiesta / On request
h.9,5 cm

ZENO PLUS



DIVANO ZENO
ZENO SOFA



BASE POUF
POUF BASE
DX / SX



CUSCINO POUF
PILLOW POUF
DX / SX



Guarda il video
Watch the video

DIVANO / SOFA

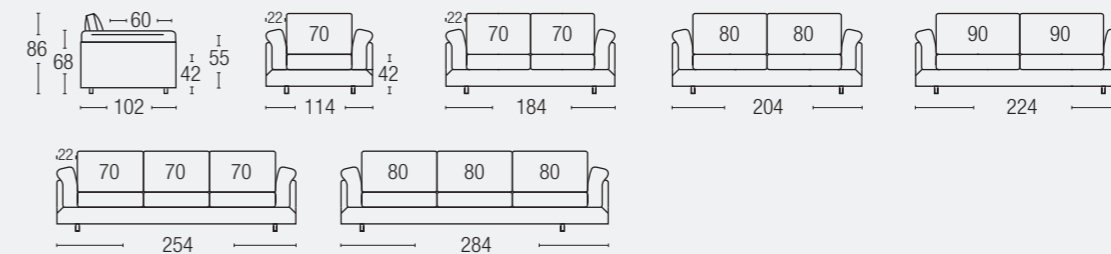

TERMINALE / ARMREST UNIT

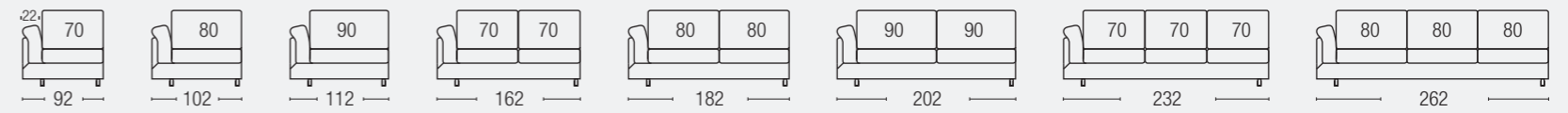

POUF

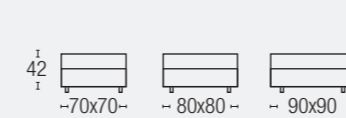

CHAISE LONGUE

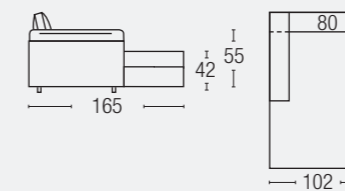

ANGOLO / CORNER

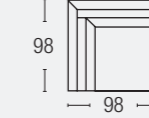

PENISOLA REVERSIBILE / REVERSIBLE PENINSULA



ZENO PLUS

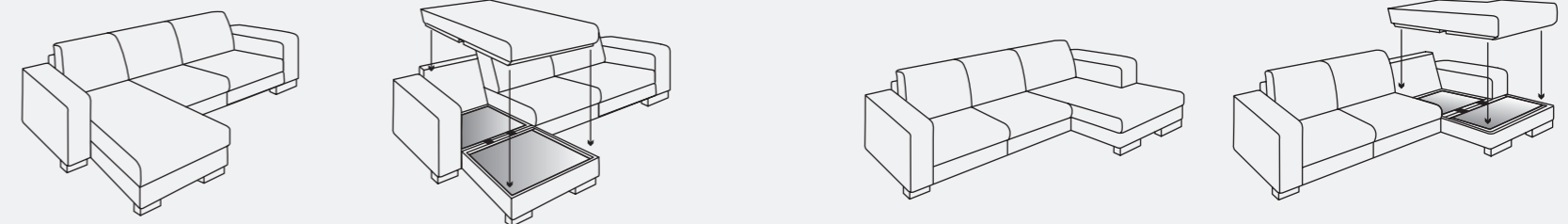

COMPOSIZIONE REVERSIBILE / REVERSIBLE COMPOSITION

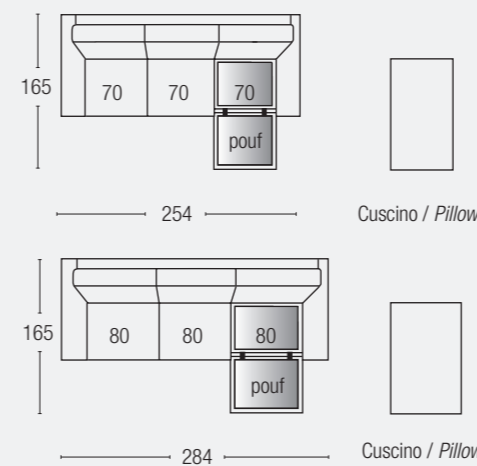

COMPOSIZIONE DX-SX / RIGHT-LEFT COMPOSITION

